

Accessories (Optional)

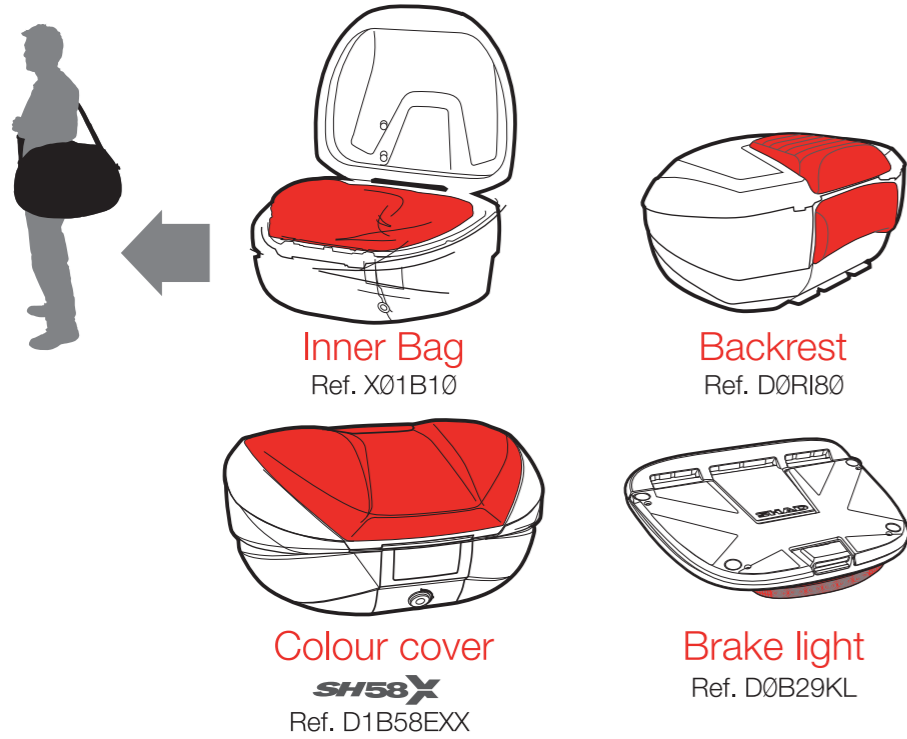

Top case support assembly

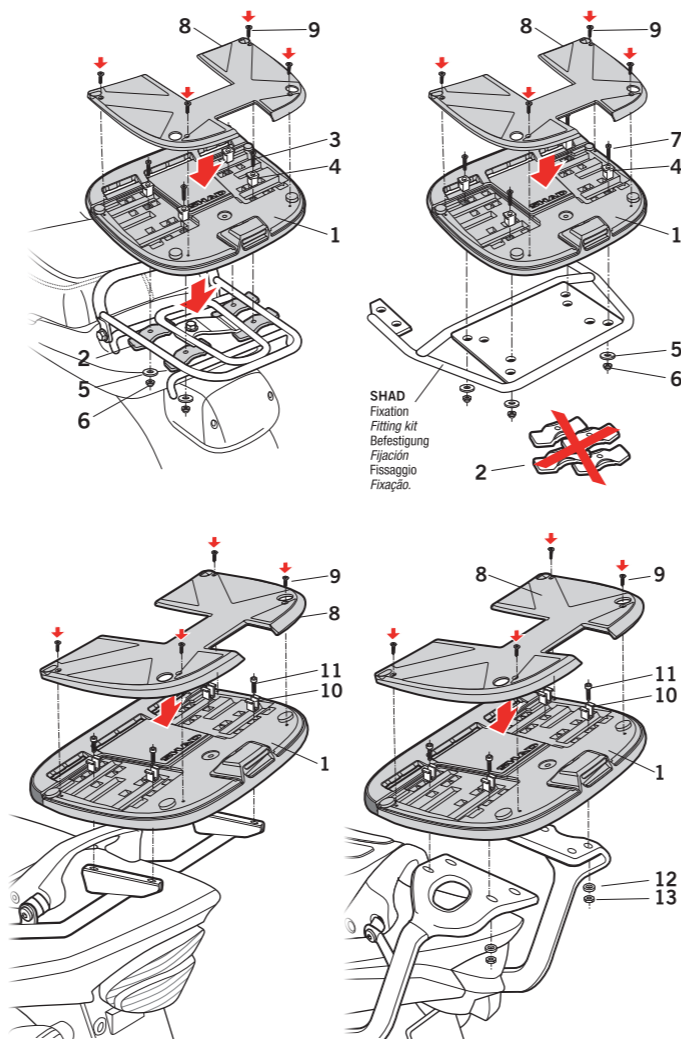

Number	Reference	Quantity
1	201834 (Support piece)	1
2	201049 (Bridle)	4
3	304144 (Screw M6x40 DIN 965)	4
4	200713/2 (Plastic bridle)	4
5	303000 (Ø6 Washer fs M6 DIN 125 A)	4
6	302021 (M6 Nut M6 DIN 985)	4
7	304058 (Screw M6x30 DIN 965)	4
8	201835 (Cover support piece)	1
9	304127 (Screw Ø3'5x13 DIN 7982)	4
10	201504 (Metal piece) *	4
11	304074 (Screw M8x20 DIN 912) **	4
12	303020 (Ø8 Washer fs M8 DIN 125 A) **	4
13	302024 (Nut M8 DIN 985) **	4

- (GB) Note:** Consult accessories with your distributor.
(*) It can only be used on the Top or Full master.
(**) Included in the specific support.
- (F) Remarque:** Consultez les accessoires avec votre distributeur.
(*) Seulement on pourrait l'utiliser sur le top et le full master.
(**) Inclus dans le support spécifique.
- (D) Anmerkung:** Auslieferer zu dem Zubehör befragen.
(*) Wird nur im Top und Full Master verwendet.
(**) Im spezifischen Halter enthalten.
- (E) Nota:** Consulte accesorios con su distribuidor.
(*) Solo se utilizará sobre el Top y Full Master.
(**) Incluidos en el soporte específico.
- (I) Nota:** Consulti gli accessori con il suo rivenditore.
(*) Solo si utilizzerà sul Top e Full Master.
(**) Inclusi nel supporto specifico.
- (P) Nota:** Consulte a lista de acessórios com o seu distribuidor.
(*) Apenas será utilizado para o Top e Full Master
(**) Incluídos no suporte específico.

SHAD INSTRUCTION MANUAL

SH58X SH59X Adventure



L Daily
From your early mornings until your late nights

XL Weekend
For your non-stop getaways

XXL Holidays
Conquer your next adventure

FAQ's and more information

SH58X



SH59X

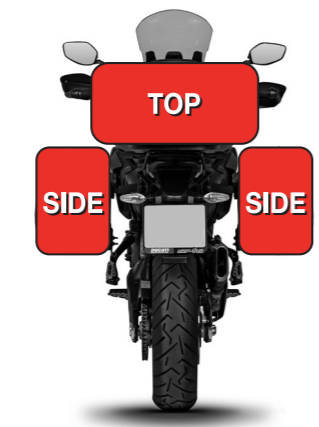

IMPORTANT WARRANTY INFO: www.shad.es

SHAD
WWW.SHAD.ES

Pol. Ind. Can Magarola
Oclave Lecante, 2-6
08100 MOLLET DEL VALLES
BARCELONA (SPAIN)

España 0034 935 795 860
France 0034 935 795 888
World 0034 935 795 867
Fax: 0034 935 796 945
info@shad.es

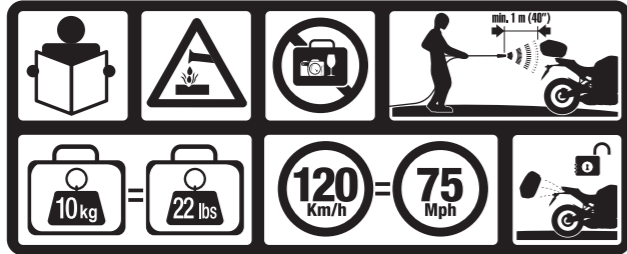

Easy to Expand

6"

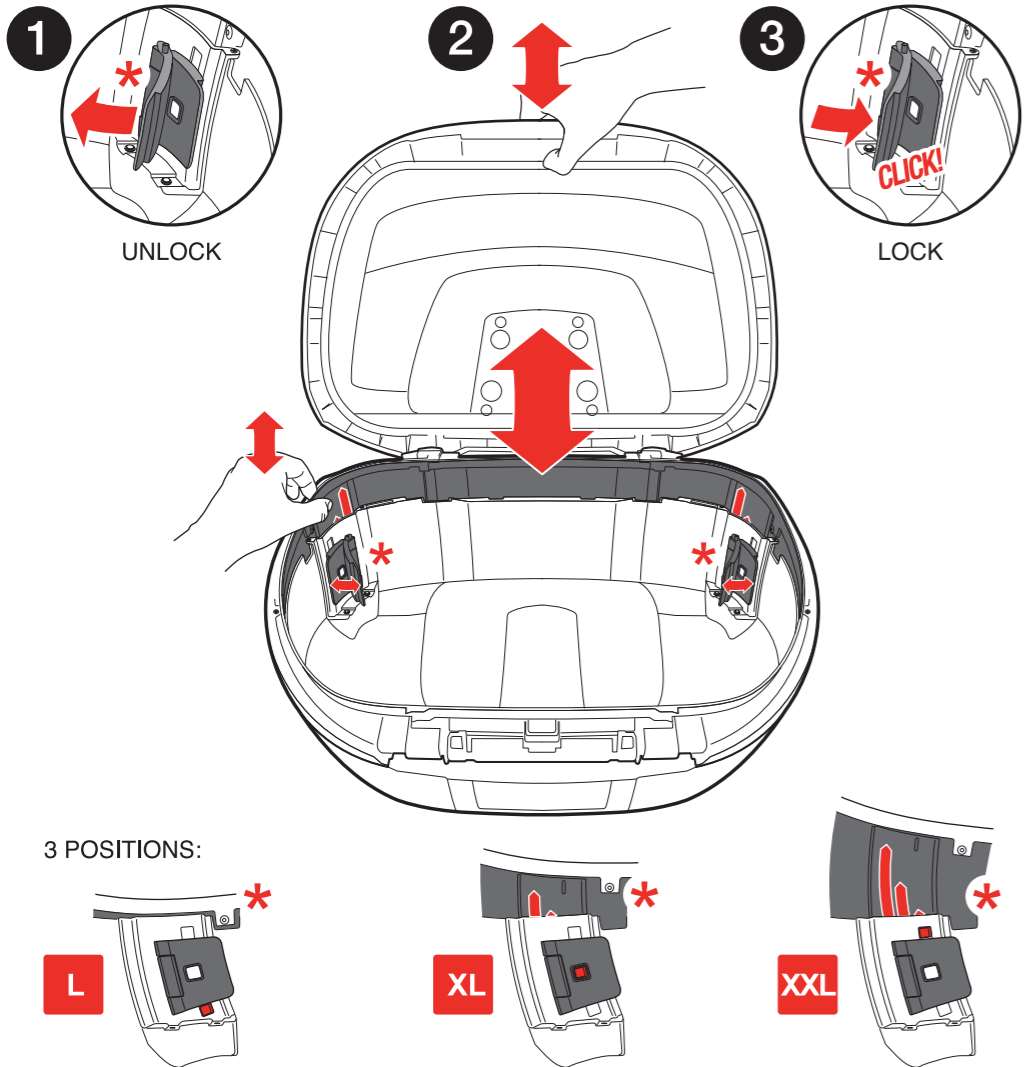

Open

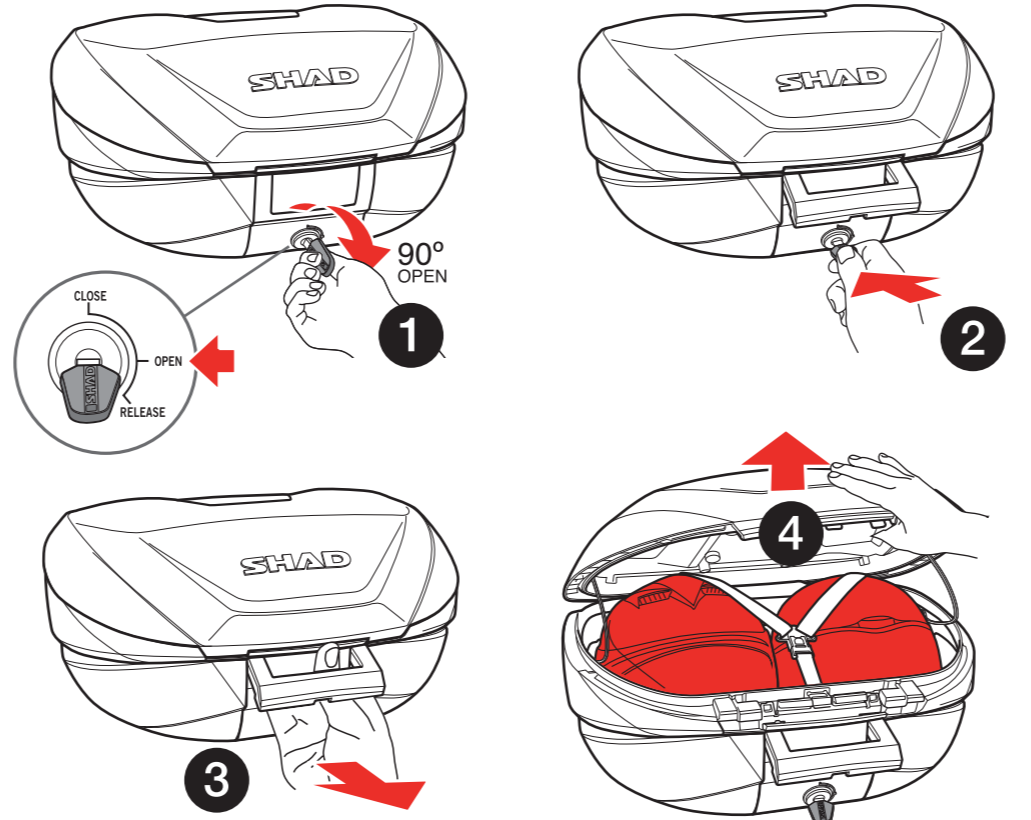

Close

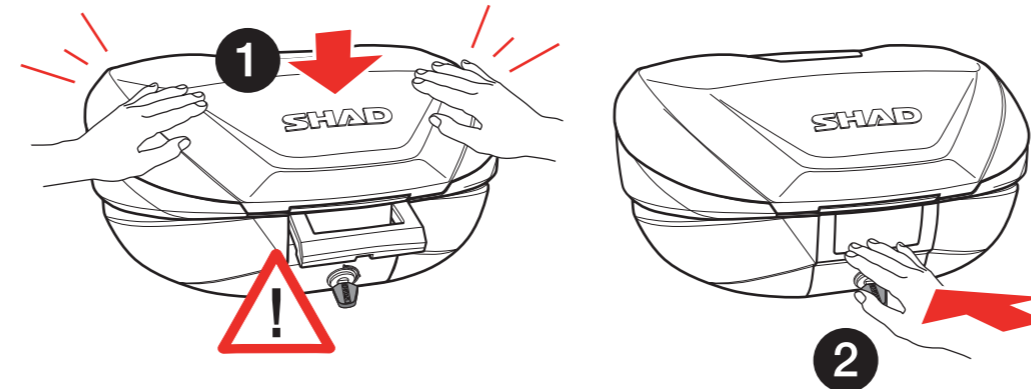

Release

